

## DNA Series Pressure Switches

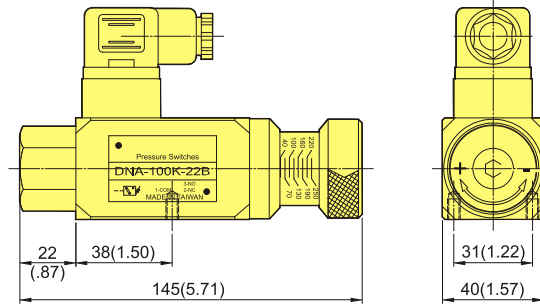
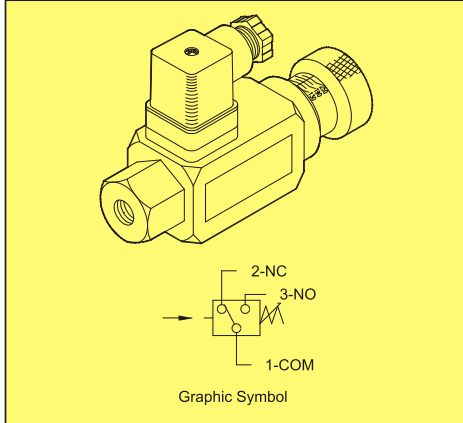

## Ordering Code

**DNA - 100K - 22B**

①                      ②                      ③

① Series  
DNA-  
Direct read-out,  
Standard type.

② Pressure Adj. Range

Model	Pres Adj. Range bar	Surge Pres. bar	Weight kg
040K	6~ 40	150	1.0
100K	15~100	250	1.0
250K	40~250	300	1.0
360K	50~360	400	1.0

③ Design Number  
22B: 1/4"PT(Rc)  
22B80: 1/4"PF(G)  
22B90: 1/4"NPT

## Hysteresis Diagrammes

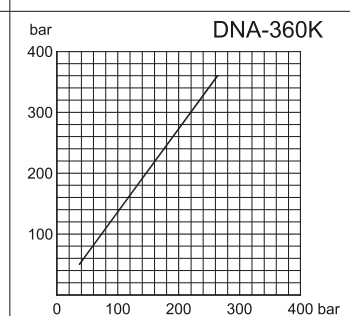
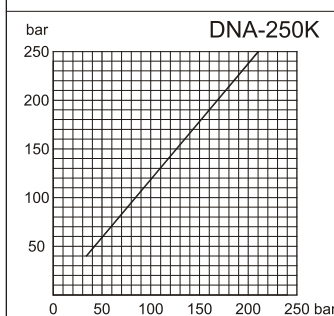
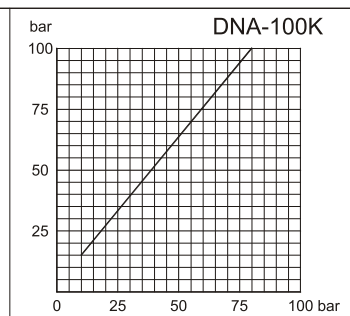
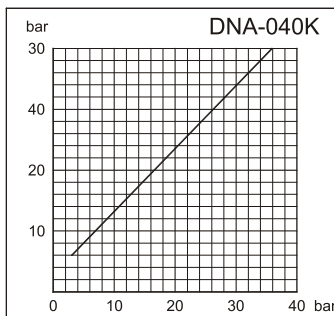

## Schematic Cross-Section

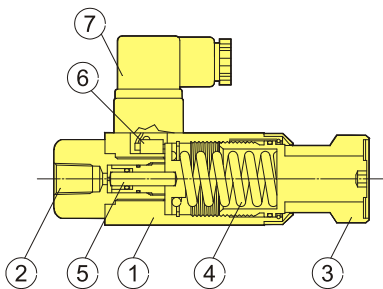

No.	Part Name
1	Body(Casting-Iron)
2	Connection Port 1/4"PT(Rc)
3	Pressure Adj. Knob
4	Spring
5	Servo-Piston
6	Micro-Switch
7	Electrical Connector