

## THROTTLE MODULAR VALVES

### Throttle Valves(Modular Type)

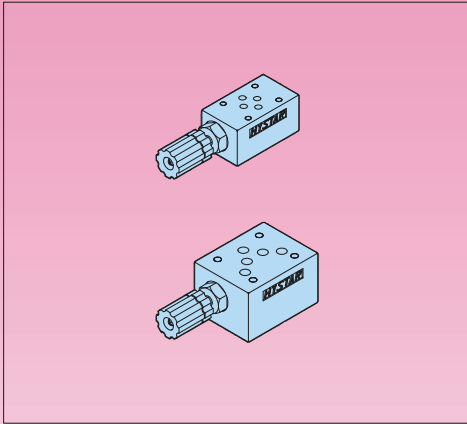

Model & Symbol	Model & Symbol
MSP-01 (03)	MSP-04 (06)

D

### Ratings

Model	Max Operating Pres bar (PSI)	Max Flow lpm (USgpm)	Valve Size	Weight kg (lb)
MSP-01	250 (3600)	50 (13.2)	1/8"	1.2 (2.6)
MSP-03	250 (3600)	100 (26.5)	3/8"	2.8 (6.1)
MSP-04	250 (3600)	190 (50.2)	1/2"	7.0 (15.4)
MSP-06	250 (3600)	300 (79.3)	3/4"	11.2 (24.6)

- The flow will be decreased when the flow adjustment handle is turned clockwise, and will be increased when the flow adjustment handle is turned counter-clockwise.
- Be sure to re-tighten the lock nut firmly after making adjustment to the flow.



### Ordering Code

**MS** - **P** - **01** - **H** - **20** - **S**

Series No	Control Line	Valve Size	Pressure Adj. Range	Design No	Option Kits
Throttle Modular Valves (for P-Port)		(DSG-) 01 (NFPA-D03)	L: 5~ 50 bar	20 DIN 912 bolts	None: With Knob DSG-01/03
		(DSG-) 03 (NFPA-D05)	H: 70~ 210 bar	2090 UNC bolts (North America)	S: Soc. Hd. Cap Screw
		(DSHG-) 04 (NFPA-D07)			
		(DSHG-) 06 (NFPA-D08)			

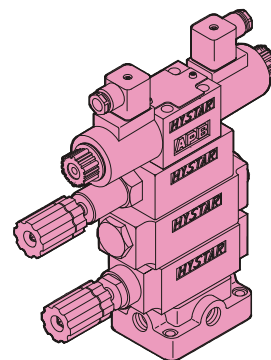

## DIMENSIONS

## MILLIMETERS(INCHES)

### MSP-01

### Throttle Valves(Modular Type)

MOUNTING SURFACE:MS\*-01-CETOP3  
ISO 03-NFPAD03

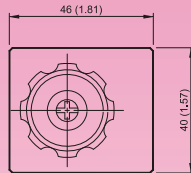

#### Valve Specifications & Attachment

Flow Rating	50 lpm (13.2 gpm)
Max. Pressure	250 bar (3600 psi)
Weight kg.(lbs.)	1.2 (2.6)
CODE:20	M5 X85LgX4pcs
CODE:2090	10-24UNCX3-1/4"LgX4pcs
Mounting Surface O-Ring	P9 x 4 pc



SYMBOL

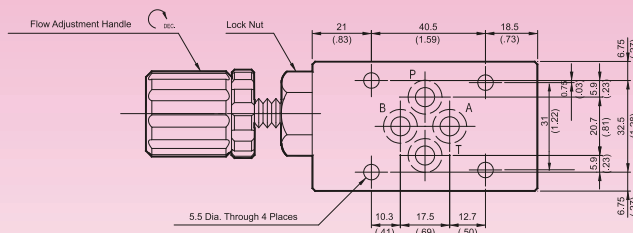

OPTION  
Design No: 30 (3090)

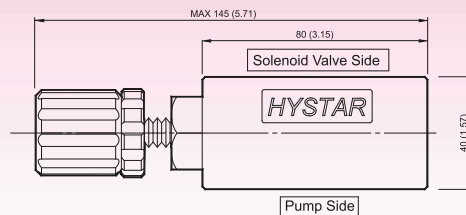
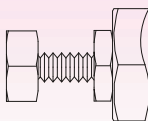

### MSP-03

### Throttle Valves(Modular Type)

MOUNTING SURFACE:MS\*-03-CETOP5  
ISO 05-NFPAD05

OPTION  
Design No: 30 (3090)

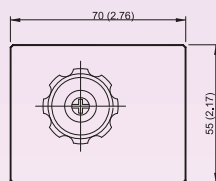
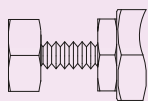

#### Valve Specifications & Attachment

Flow Rating	100 lpm (26.5 gpm)
Max. Pressure	250 bar (3600 psi)
Weight kg.(lbs.)	3.0 (6.6)
CODE:20	M6 X90LgX4pcs
CODE:2090	1/4-20UNCX3-1/2LgX4pcs
Mounting Surface O-Ring	P12 x 5 pc



SYMBOL

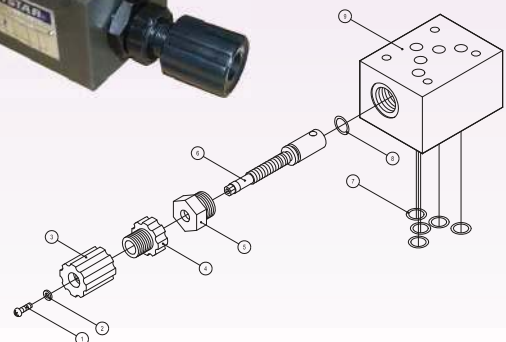
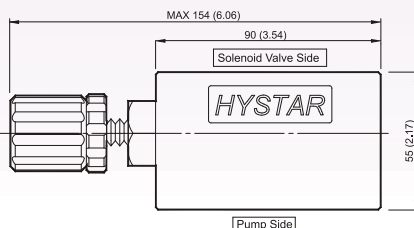
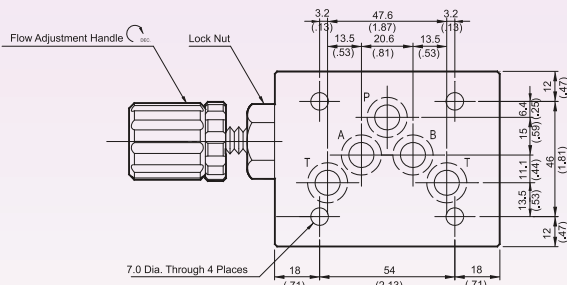

## DIMENSIONS

## MILLIMETERS(INCHES)

### MSP-04 Throttle Valves(Modular Type)

MOUNTING SURFACE:MSP-04-CETOP7  
ISO 07-NFPAD07



SYMBOL

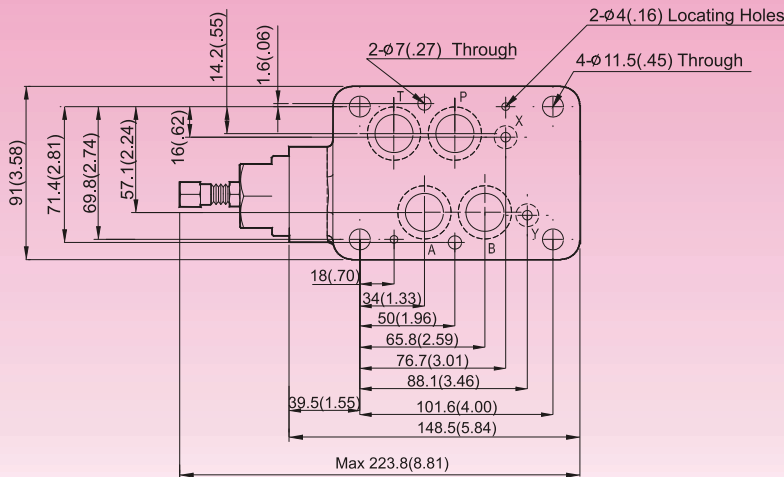

#### Valve Specifications & Attachment

Flow Rating	190 lpm (50.2 gpm)
Max. Pressure	250 bar (3600 psi)
Weight kg(lbs.)	7.0 (15.4)
CODE:20	M6X125LgX2pcs M10X120LgX4pcs
CODE:2090	1/4-20UNCX4-7/8"LgX2pcs 3/8-16UNCX4-5/8"Lg X4pcs
Mounting Surface O-Ring	P9 x 2 pc & P22A x 4 pcs

### MSP-06 Throttle Valves(Modular Type)

MOUNTING SURFACE:MSP-06-CETOP8  
ISO 08-NFPAD08



SYMBOL

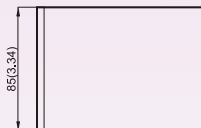
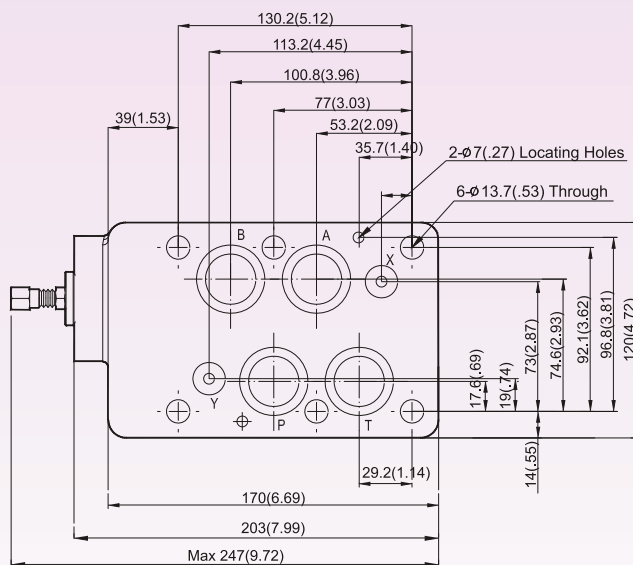

#### Valve Specifications & Attachment

Flow Rating	300 lpm (79.3 gpm)
Max. Pressure	250 bar (3600 psi)
Weight kg(lbs.)	11.2 (24.6)
CODE:20	M12X140LgX6pcs
CODE:2090	1/2-13UNCX4-5/8"Lg X6pcs
Mounting Surface O-Ring	P12 x 2 pc, P28 x 4 pcs